

DGH A3000 Configuration Guide

For use with DGH Modules



Revision Date: 12/07/05 **Version:** 1.00

Contact Information:

<http://www.dghcorp.com>

Ph: (603) 622-0452

Fax: (603) 622-0487

Mailing Address:

DGH Corporation
P.O. Box 5638
Manchester, NH 03108

Shipping Address:

DGH Corporation
146 Londonderry Turnpike
Hooksett, NH 03106

Disclaimer:

The information in this publication has been checked and believed to be accurate; however, no responsibility is assumed for possible in-accuracies or omissions. Applications information in this manual is intended as suggestions for possible use of the product and not as explicit performance in a specific application. Specifications may be subject to change without notice.

The A3000 is not an intrinsically safe device and should not be used in an explosive environment unless enclosed in an approved explosion proof housing.

Table of Contents:

1. [Product Label](#)
2. [Packing List](#)
3. [Module Setup Configuration](#)
4. Hardware Connections
 - [RS-232 Module Connections](#)
 - [RS-485 Module Connections](#)
5. [A3000 Ethernet Configuration](#)
6. [A3000 Serial Port Settings](#)
7. [Computer Configuration](#)
 - [Virtual Serial Port Driver Installation](#)
8. [Test the Connection](#)
 - [DGH Utility Software](#)
 - [Windows Hyper-Terminal](#)
9. [A3000 Specifications](#)
10. [Ordering Guide](#)
11. [Serial DB-9 Connector Pin-Out](#)
12. [Mechanical Dimensions](#)
13. [DIP Switch Settings](#)

A3000:

Label

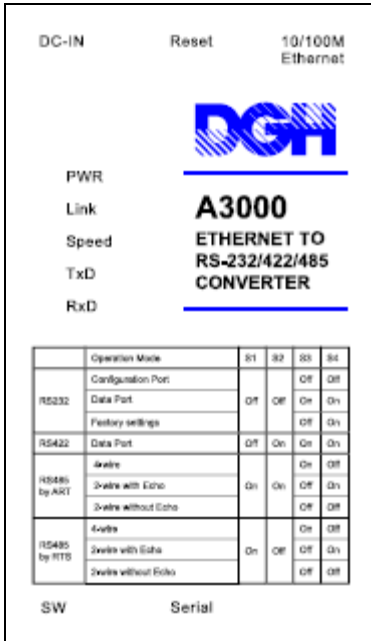

LED and Descriptions

LED	Description
PWR	The Red Power LED will illuminate when the power is applied to the A3000.
LINK	Connect a network cable from your Hub or Switch into the RJ45 jack of the A3000. The Yellow Link LED will illuminate. This LED will flash when data is present on the network.
SPEED	If you have a 100Mbit network connection then the Green Speed LED will illuminate. If you have a 10Mbit network connection then the LED will remain off.
TxD	The TxID LED will flash when data is transmitted to the device connected on the serial port.
RxD	The RxID LED will flash when the device connected to the serial port transmits its data.

Packing List:

- A3000 Ethernet Converter
- AC Power adapter, output +9Vdc @ 0.5 amps.
- Serial Null Modem adapter.
- CD-ROM containing device drivers, Quick Start Guide, and configuration software.

Configuration and Connection Guide using DGH Modules:

This document contains a list of configuration steps to quickly configure and connect a DGH module to a DGH A3000 Serial to Ethernet converter. These steps are described in proper order and connection diagrams are provided for using the A3000 with either a DGH RS-232 or the RS-485 module. Please note that any alterations to the DGH module setup configuration should be made before connecting the module to the A3000 converter.

Module Setup Configuration:

The DGH modules and the A3000 must be configured before they can be connected. There are several user-selectable parameters in every DGH module that can be set or left in their default condition. These parameters are application specific and must be determined before being installed in the application system.

Determine user-selectable parameters such as the Device Address, Baud Rate, and Parity type before configuring and connecting the modules and the A3000 together. Once these values have been determined, connect the module(s) to the host computer individually using one of the diagrams below.

Once the wiring is complete, turn on the Power Supply and plug the serial cable into the RS-232 port of the host computer. Be sure to connect the "Default*" terminal to GND terminal as illustrated below.

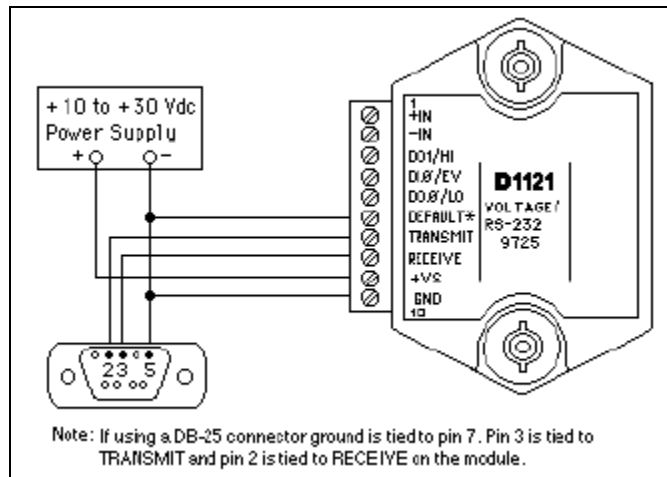

Connecting RS-232 Module to Host Computer.

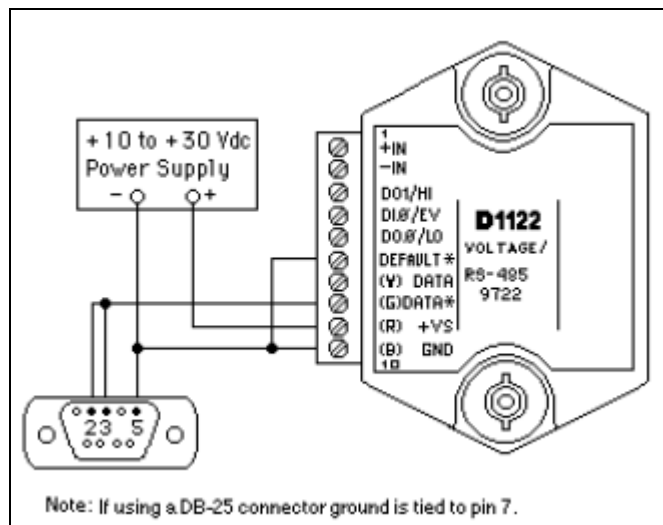

Connecting RS-485 Module to Host Computer.

Install the DGH Utility software from the CD-ROM shipped with your order. Run the Setup.exe program from the CD. After the installation is complete, run the DGH Utility Software program. Select "Setup" on the main menu and then select "Modules".

Click on the "Settings" button to open the proper serial port. The port settings should be: 300 baud, Mark Parity, 7 Data bits, 1 Stop bit and RTS Only flow control. The TX and RX delays should be left alone in their default conditions.

Return to module setup screen and select the Model Number, Device Address is "1" and press "Read Setup" button. Adjust the Device Address, Baud Rate and any other parameters to their correct (application specific) values. Finally, apply the changes. Repeat this process for each individual module in the system. Note: Each module must have a unique address to avoid communications collisions.

After all the modules are configured, they can be connected to the A3000 Serial to Ethernet converter. A cable is required to connect the module to the serial port of the A3000. The A3000 serial port DIP Switches must also be set for the proper communications standard. The serial cable connections are detailed below for either an RS-232 or RS-485 module to the A3000 serial port. Use the proper connections and DIP Switch settings to ensure communications with the module.

RS-232 Module Connections:

After the modules have been configured, connect them to the A3000. First, ensure that power is "Off" or disconnected from both the A3000 and DGH Module before completing the following steps:

1. Set the DIP Switches on the A3000 module for Switches 1 and 2 "Off" (Down) and Switches 3 and 4 "On" (Up).

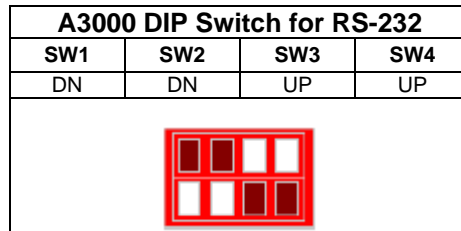

2. Connect a DGH module to the A3000 converter using a DGH CA-3 cable and the DB-9 null modem adapter supplied with the A3000 converter.
 - a. Apply the DB-9 null modem adapter to the DB-9 connector on the A3000.
 - b. Insert the DB-9 end of the DGH CA-3 cable into the DB-9 null modem adapter.
 - c. Make the following connections from the DGH CA-3 to the DGH Module terminals. All undesignated wires in the CA-3 should be left unconnected.

Serial Port Connections	
CA-3 Wire	Module Terminals
GREEN	GND
RED	RECEIVE
ORANGE	TRANSMIT

3. Connect the AC power adapter cable to the Power Supply jack at the rear side of the A3000. Plug the AC adapter into a wall outlet and the Red Power LED will illuminate. Apply power to the DGH module.
4. Advance to "[Ethernet Setup](#)" below.

RS-485 Module Connections:

After the modules have been configured, connect them to the A3000. First, ensure that power is “Off” or disconnected from both the A3000 and the DGH Module and then complete the following steps:

1. Set the DIP Switches on the A3000 module for Switches 1 and 2 “On” (Up) and Switches 3 and 4 “Off” (Down).

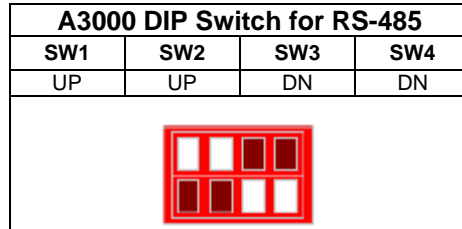

2. Connect a DGH module to the A3000 converter using a DGH CA-3 cable and the DB-9 null modem adapter supplied with the A3000 converter.
 - a) Apply the DB-9 null modem adapter to the DB-9 connector on the A3000.
 - b) Insert the DB-9 end of the DGH CA-3 interconnect cable into the DB-9 null modem adapter.
 - c) Make the following connections from DGH CA-3 to DGH Module terminals. All undesignated wires in the CA-3 should be left unconnected.

Serial Port Connections	
CA-3 Wire	Module Terminals
GREEN	(B) GND
YELLOW	(G) DATA*
ORANGE	(Y) DATA

3. Connect the AC power adapter cable to the Power supply jack at the rear side of the A3000. Plug the AC adapter into a wall outlet and the Red Power LED will illuminate. Apply power to the DGH module.

Ethernet Setup:

The A3000 converter can be configured using either a direct connection to a host computer Network Interface Card (NIC card) or by connecting to a network that contains a DHCP server. Direct connections require the factory default IP address (192.168.254.254) to communicate with the A3000. Direct connections are preferred as the IP address is known. DHCP connections allow the A3000 to receive an IP address automatically from a network DHCP server. This method will require the A3000 Net Manager software, or another method such as a router DHCP Client List table, to determine the present IP address before configuring the device.

Using a direct Ethernet connection method for the first time, the default IP address should be used to communicate with the A3000 in a web browser. Simply connect an Ethernet CAT-5 “cross over” cable between the computer and the A3000. Ensure that the NIC card contains an IP address with the first three octets set to the same values as Default IP in A3000. For example, manually set the NIC card IP address to 192.168.254.1. This would be done in the Windows Device Manager under “Network Adapters”. Then open a web browser and type <http://192.168.254.254> into the URL address line.

Using a connection with a DHCP server, the DHCP server will provide the A3000 with an IP address automatically. The A3000 Net Manager software is the easiest way to determine the new IP address. Open a web browser and enter the IP address into URL address line. The A3000 is factory configured for DHCP Enabled.

Note: If DHCP mode has been disabled and/or alterations have been made to the configuration, then the default IP Address may have been changed and might not work. In this case, use the Net Manager software to determine the present IP address.

The configuration page of the A3000 should load similar to the image below.

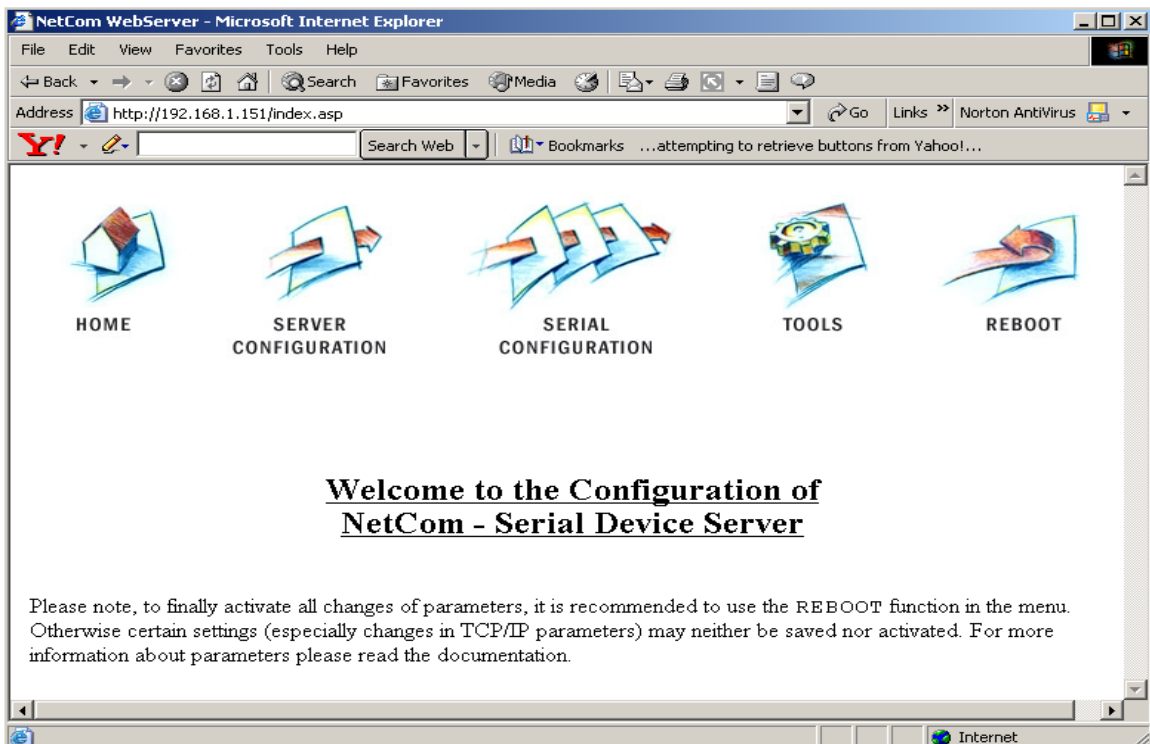

Complete the following steps to properly configure your A3000 converter:

1. Move the computer mouse over the “Server Configuration” selection and double-click the mouse left button.

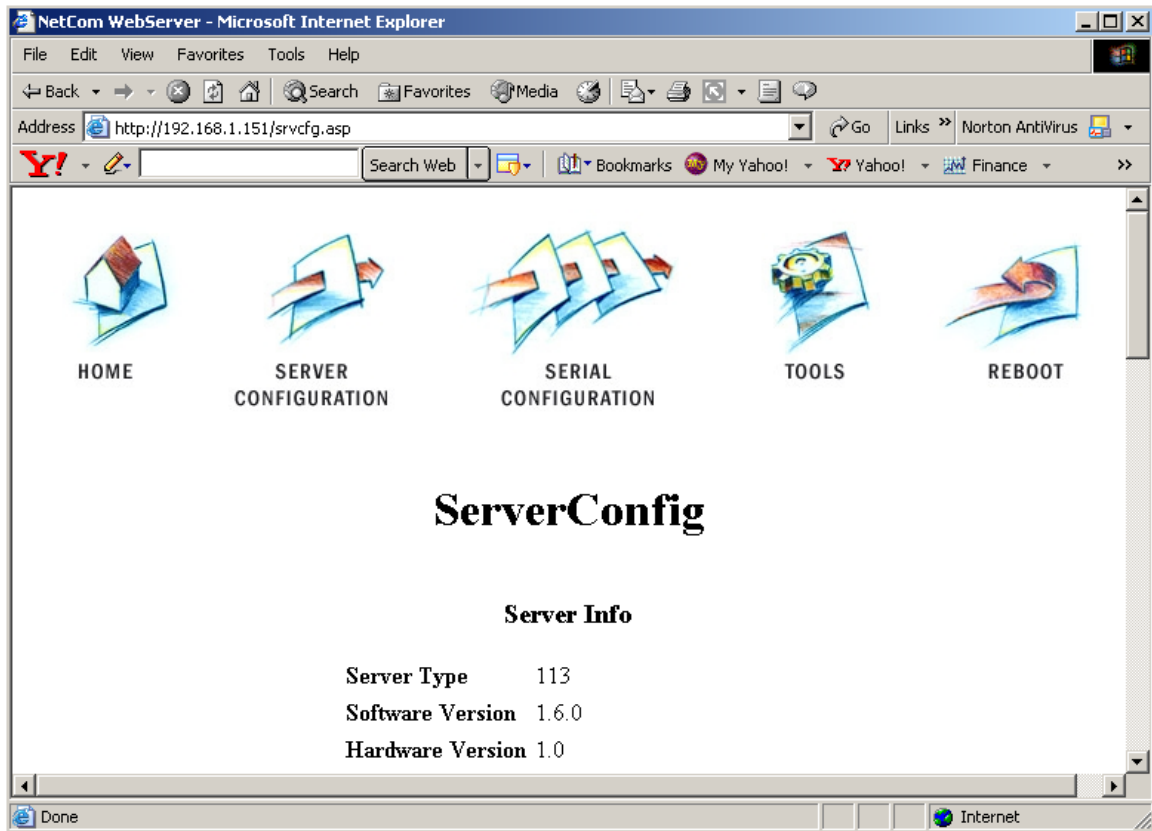

2. Move down the page to the Server Parameter configuration values. Depending on the application, the A3000 can receive an IP Address automatically or be programmed to a specific IP Address. If the DHCP drop-down list box indicates “Enabled” then the A3000 must be connected to a device, router, server, or other hardware that will provide the converter with an IP address. If DHCP list box indicates that DHCP “Disabled” then the converter must be assigned a specific IP Address and will utilize that IP Address each time the converter is power up.
3. Other network specific values may need to be entered such as: Netmask, Broadcast Address, Gateway, DNS, and Domain. These values are specific to the computer network to which the A3000 will be connected. See your system administrator for this information.

Serial Port Setup:

The A3000 Serial Port settings must be configured to match the settings of the DGH module. From the A3000 main menu in the web browser, click on the "Serial Configuration" icon.

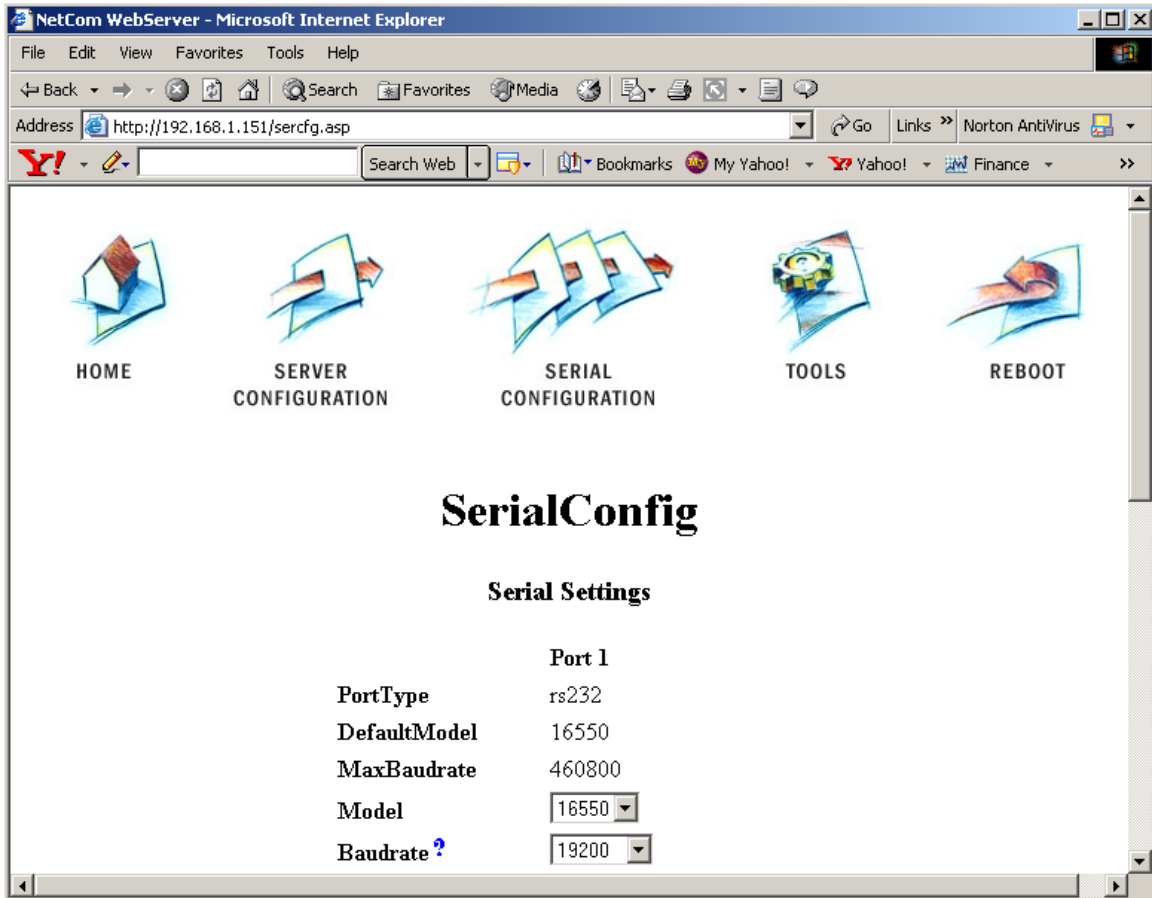

Select the Serial Port Baud Rate, Parity, Data Bits and Stop Bits. The valid data settings for communicating with a DGH module would be: 8-N-1, Odd-7-1, or Even-7-1. For example, if the module is configured for 19.2K Baud and Even Parity then set the Baud Rate to 19.2K, 7 Data Bits, 1 Stop Bit, and Even Parity.

Note: All other user-selectable options can normally be left in their Default condition. In some applications it might be necessary to alter those values.

Computer Configuration:

In order for a host computer to easily communicate with serial devices connected to an A3000 a virtual serial port to Ethernet driver must be installed on the host computer. The virtual serial port driver is a software program that emulates a standard serial communications port in the computer. The virtual software driver redirects the data to the computer Ethernet port. Likewise any data that is returned from the A3000 is redirected back to the virtual software driver and reported back to the application program. This virtual software driver allows existing programs to read or write information through the Ethernet port without any hardware or computer programming modifications.

Virtual Serial Port Driver Installation:

In order to communicate between a host supervisory computer and an A3000 a device driver must be installed on the host computer. The device driver will install a “virtual” communications port on the host computer. This driver will require the IP number of the A3000. Before installing, contact your Network Administrator for correct network IP Address, Netmask, and Default Gateway values that will be installed into the A3000.

Begin the driver installation process by inserting the DGH CD-ROM into the computer CD-ROM drive. The CD will automatically run and present a list of installation options. Select “A3000 Ethernet and Drivers”. Next, click on the driver installation link that matches the computer Operating System installed on your computer. A folder will open up and display all the driver installation files. Run the installation file (click on the icon) as specified in the Table below.

Device Driver Installation	
Operating System	Filename
Windows 2000	Vsnsetup.exe
Window NT 4.0	Vsnstunt.exe
Windows XP, XP-Pro	Vsnsetup.exe
Windows 2003	Vsnsetup.exe

The driver installation program will install the device drivers and the Network Manager. The Network Manager is used to configure and detect A3000's that are connected to your intranet.

After the installation process is complete, a brief check in the system Device Manager will indicate that at least one additional serial port has been added to the machine. The additional port will be designated as “NetCom COM Port (COMn)”. See below.

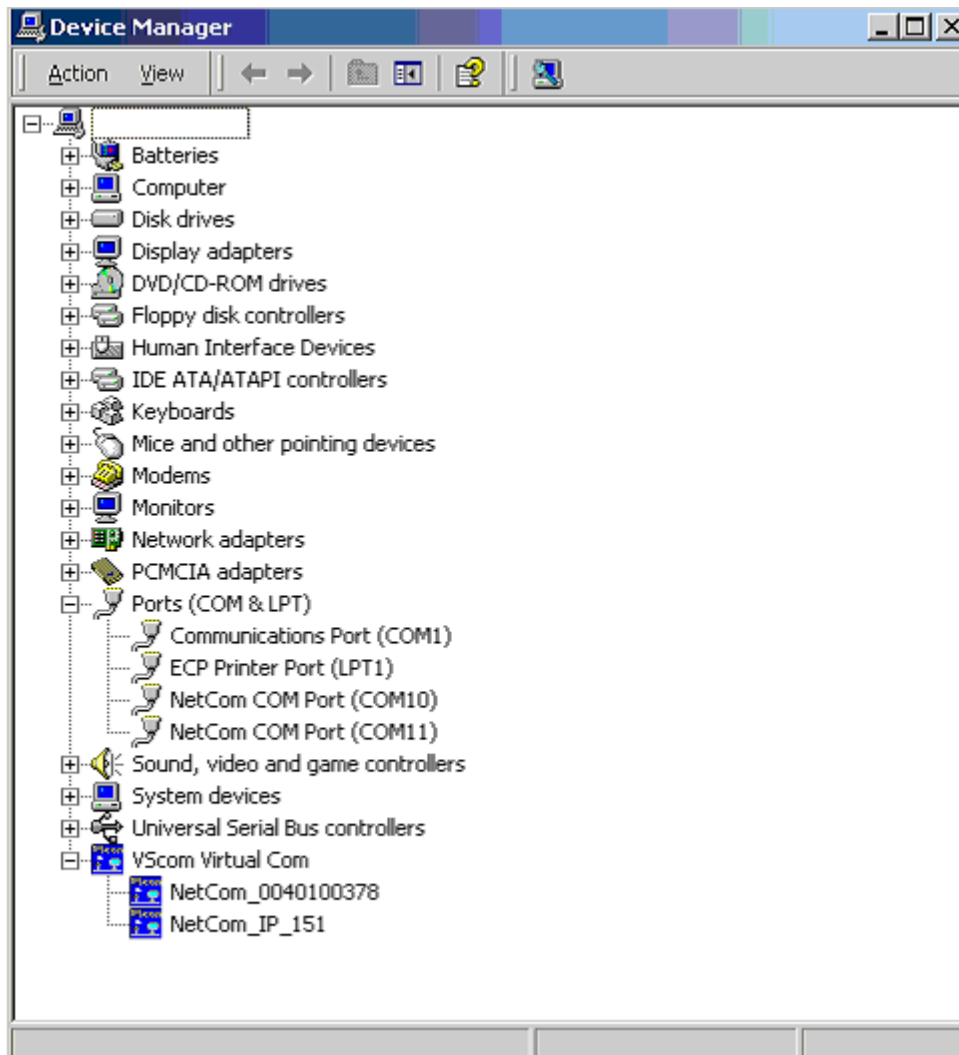

Test the Connection:

There are two ways to quickly test the Ethernet connection to your A3000 converter. The DGH Utility Software or the Windows Hyper-Terminal software program can be used to communicate with a DGH module that is connected to an A3000. The DGH Utility software is available on CD-ROM with a purchase order. It can also be downloaded from the DGH website (www.dghcorp.com).

Windows Hyper-Terminal can be used to manually communicate with a DGH module thru an A3000 converter. Hyper-Terminal is an optionally installed program that comes on the MS-Windows Operating System CD-ROM. You can check to see if Hyper-Terminal is installed on your machine by following these menu selections: select the Windows "Start" button, then "Programs", "Accessories" and the "Communications" menu selections. If Hyper-Terminal is installed it will appear on the Communications menu. If it does not appear, the program should be installed before using the instructions below.

Windows Hyper-Terminal Instructions:

The A3000 Ethernet converter can be tested using the Windows "Hyper-Terminal" terminal software program. Hyper-Terminal can be started by clicking on the Windows "Start" button, followed by clicking on menu selections: "Programs", "Accessories", "Communications" and

Hyper-Terminal. Once the program is started and running, the serial port parameters must be properly configured by selecting "File" and "Properties". Next, the serial port properties dialog screen will open.

In order to communicate with a DGH module that is connected to an A3000, a "direct connection" to a computer serial port must be established within Hyper-Terminal. The Hyper-Terminal software communicates information through a serial communications port inside the host computer. Since the A3000 converter interfaces directly to an Ethernet network, and not a computer serial port, a virtual serial port software driver must be used to convert the Hyper-Terminal information into Ethernet packets. The software driver will transmit the information on to the network. Then the A3000 receives the packets from the network and transmits data through the A3000 DB-9 serial port. Note: The software virtual COM port driver software must be installed on the host computer before proceeding beyond this point.

The Hyper-Terminal serial port connection includes setting a "direct connection" to the virtual serial port (COMn:). Then the serial port parameters such as Baud Rate, Parity Type, Data bits, Stop bits and Flow Control should be properly configured. The Baud Rate, Parity Type and Data Bits should be set to the same values as configured for the DGH module. The Stop Bits should be set to one bit and Flow Control should be set to 'none'. Apply the new settings and make sure that the connection to the COMn: port was opened successfully.

Connect a DGH RS-232 module to the DB-9 serial port and apply power to the module and A3000. Type a typical DGH command into Hyper-Terminal (\$1RD<enter>) and view the response message. The "<enter>" is the Enter key on the computer keyboard. If the module responds properly then the connection has been successfully tested.

DGH Utility Software Instructions:

The DGH Utility Software can be used to test the Ethernet connection between a computer and a remote A3000 converter. The Utility Software is distributed on CD-ROM with a purchase order. It can also be downloaded from the website (www.dghcorp.com). The Utility Software should be installed on a computer before proceeding with the instructions below.

Start the test by running the Utility Software. Ensure that power is applied to the A3000 and the DGH module. From the Utility Software main menu, click on "Tools" and then "ASCII Command Line Editor". A small dialog screen will appear. Click on the "Settings" Button to specify the correct computer "Serial Port". Then specify the communications parameters: Baud Rate, Parity Type, Data Bits, and Stop Bits. The Delay times on the right side should work in their original condition. Press the "Open" or "Update" button after all parameters are properly configured.

After the port parameters have been applied, DGH protocol commands can be sent through the serial port over the network to the A3000. The A3000 will convert the commands to serial data and transmit the command characters onto the RS-232 data lines (on the DB-9 connector). After receiving the characters, the DGH module will respond with information/data that pertains to the specific command. The response characters are transmitted back to the computer through the A3000 and the Ethernet connection.

The response data is then displayed on the computer screen in the "Response" line area of the dialog screen. If data values are displayed the connection has been successfully tested. If the word "TIMEOUT" appears, the device did not respond.

TECHNICAL Specifications

- 1 Serial Port, DIP Switch configurable for RS-232/RS-422/RS-485.
- Fast Ethernet auto-detecting.
- Drivers for virtual serial ports: Win2K, Win XP/XP-Pro, WinNT 4.0.
- TCP Raw Connection Server/Client Mode.
- UDP data transfer
- Configuration via web-browser.
- Protocols: TCP/IP, UDP, HTTP, Telnet, SNMP, DHCP, ICMP, and DNS.

ORDERING Guide

- A3000-110V, 1 port RS-232/RS-422/RS-485.
- A3000-220V, 1 port RS-232/RS-422/RS-485.

Available Options

- MK-1, DIN-Rail Mounting Adapter.
- CA-6, Network Cable, CAT-5, 3ft.

Driver Download:

<http://www.dghcorp.com>

Product Information:

<http://www.dghcorp.com/ethernet>

Purchase:

<http://www.dghcorp.com>

DB-9 Female Pin Out

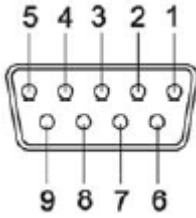

Pin #	RS-232	RS-422	RS-485
1	DCD	RX- (A)	
2	TXD	RX+ (B)	
3	RXD	TX+ (B)	Data+ (B)
4	DSR	TX- (A)	Data- (A)
5	GND	GND	GND
6	DTR		
7	CTS		
8	RTS		
9	RI		

Mechanical Dimensions

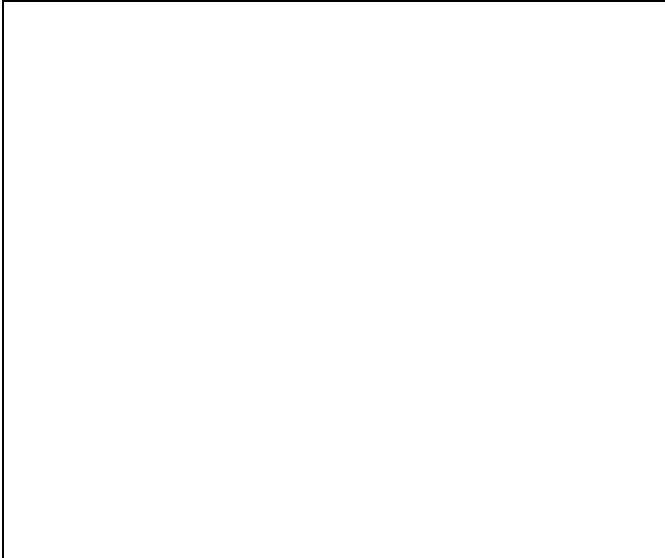

Switch Settings

RS-232

Mode	Switch Position
Configure by Serial Port	
Data Communication	
Reload Factory Values	

RS-422

Mode	Switch Position
Data Communication	

RS-485 by ART

Mode	Switch Position
4-Wire Full Duplex	
2-Wire Half Duplex, with Echo	
2-Wire Half Duplex, w/o Echo	

RS-485 by RTS

Mode	Switch Position
4-Wire Full Duplex	
2-Wire Half Duplex, with Echo	
2-Wire Half Duplex, w/o Echo	

Notes: